

WITHROBOT Inc.

USER MANUAL

oCam-1MGN-U

Version 1.0

July 2017



www.withrobot.com

Copyright(c) 2017 WITHROBOT Inc. All rights reserved.

Document version history

Date	Document version	Description
Oct. 2017	1.0	Initial release

TABLE OF CONTENTS

DOCUMENT VERSION HISTORY	1
1. INTRODUCTION	4
1.1. Specifications.....	4
1.2. Applications.....	4
1.3. Technical resource.....	5
2. SPECIFICATIONS	6
2.1. PCB dimensions.....	6
2.2. External look.....	6
2.3. Electrical specifications.....	7
2.4. Camera specifications.....	7
3. HOW TO CONNECT OCAM-1MGN-U TO WINDOWS HOST	8
3.1. Connection of oCam-1MGN-U to host computer.....	8
3.2. oCam-Viewer installation	8
3.3. Run the oCam-Viewer.....	9
4. HOW TO CONNECT OCAM-1MGN-U TO LINUX HOST	12
4.1. oCam-Viewer download & build.....	12
4.2. Connection of oCam-1MGN-U to host computer.....	12
4.3. Run the oCam-Viewer.....	13
5. FIRMWARE UPDATE.....	15
6. RECOMMENDATIONS.....	16
7. FAQs.....	17
7.1. Gucvview	17
7.2. DIY Fixture	17
7.3. Technical support.....	17

APPENDIX..... 18

1. DEFAULT M12 LENS SPECIFICATIONS..... 18

2. M12 LENS HOLDER DIMENSIONS..... 20

3. TRIPOD MOUNT: OCAM-TM 21

1. Introduction

The oCam-1MGN-U is a Global Shutter, 1 Mega pixel, Mono, UVC compliant, USB3.0 SuperSpeed camera from WITHROBOT Inc. It uses AR0134 of On Semiconductor as the image sensor and provides the image through USB3.0 interface to be easily connected to hosts with USB3.0 ports. The camera is backward compatible with USB2.0 interface, so for the hosts with USB2.0 ports, the connection is automatically adjusted to High Speed interface.

As the camera supports UVC1.0 specifications, the images of various resolutions of 1280 x 960(45FPS), 1280 x 720(60FPS), 640 x 480(80FPS), 320 x 240(160FPS) are readily available to hosts of Linux or Windows operating systems without any special drivers. The electronic global shutter mechanism of the camera provides clear images with less blur. The oCam-1MGN-U with M12 lens holder allows various M12 lenses to be interchangeably used on the camera to suit to various applications.

1.1. Specifications

- Sensor: OnSemi AR0134 CMOS image sensor
- Sensor Size: 1/3 inch
- Interface: USB 3.0 SuperSpeed
- Power: USB bus power
- Operating temperature: 0°C~70°C
- Rating: DC5V/180mA
- Shutter: electric global shutter
- Field of View (FOV): 65°
- Camera Control: Exposure, Brightness, Auto-Exposure
- Weight: 33.5 g
- PCB Size: 39 x 39 mm
- Case Size: 42 x 42 x 17 mm
- Lens: M12 type lens

1.2. Applications

- Computer vision
- Web cam
- Embedded camera
- Visual servo for face tracking

- Smart camera

1.3. Technical resource

Latest updates of the related firmware and software are available at

<https://github.com/withrobot/oCam/tree/master/Products/oCam-1MGN-U>.

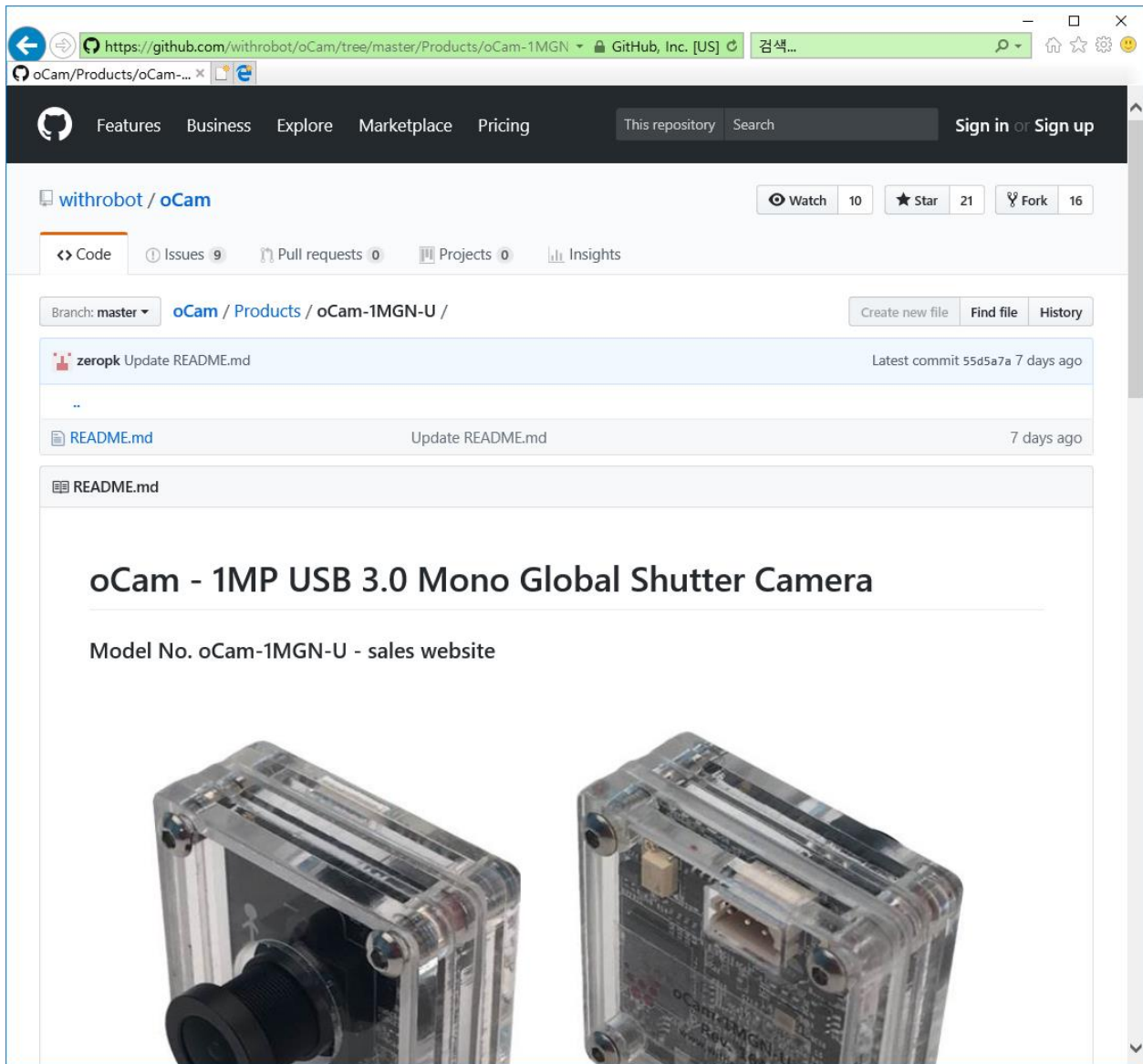

Figure 1. Online technical resource repository.

2. Specifications

2.1. PCB dimensions

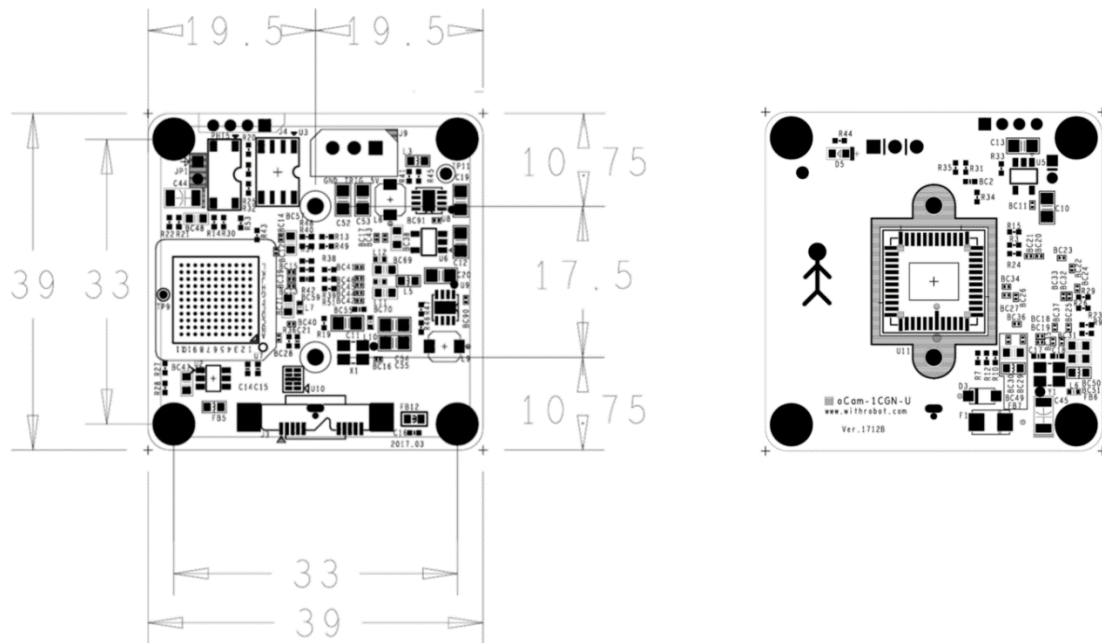

Figure 2. PCB dimensions (in mm)

2.2. External look

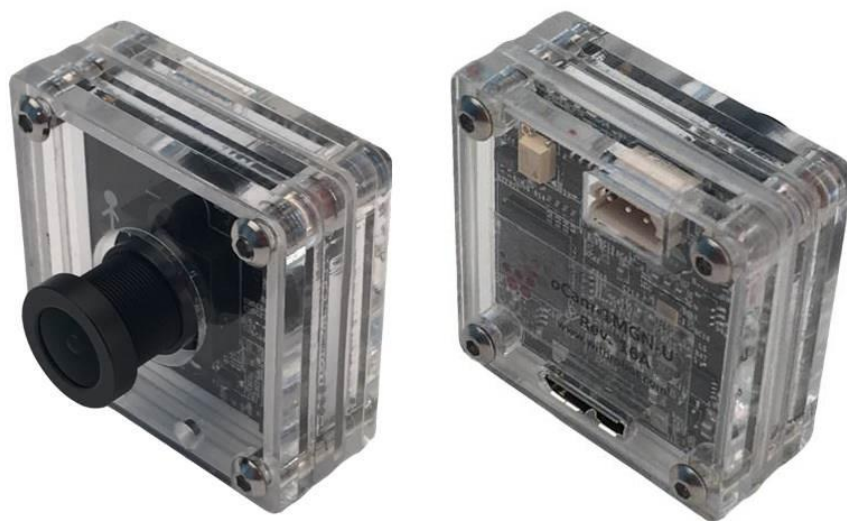

Figure 3. External look (42 x 42 x 17mm)

2.3. Electrical specifications

Item	Min	Max	Unit
Source Voltage, VDD		5.0	V
Current		180	mA
Operating Temperature	-40	85	°C

Table 1. Electrical specifications

2.4. Camera specifications

Item	Specification	Notes
Image type	Monochrome	
Image resolutions	1280 x 960(45fps)	
Horizontal x Vertical (FPS)	1280 x 720(60fps) 640 x 480(80fps) 320 x 240(160fps)	
Shutter	Global Shutter	
Camera control	Brightness Exposure (Absolute)	
Auto Exposure	Supported	
Auto White Balance	Not supported	
External Trigger	Not supported	
Lens Correction	Not supported	
White Balance Auto Setup	Not supported	

Table 2. Camera specifications

3. How to connect oCam-1MGN-U to Windows host

3.1. Connection of oCam-1MGN-U to host computer

- Insert USB3.0 cable to oCam-1MGN-U.
- Connect USB3.0 cable to USB3.0 port of the host computer.
- Wait about 1 minute until the message window appears.
- The oCam-1MGN-U should appear on the device list in the Device Manager

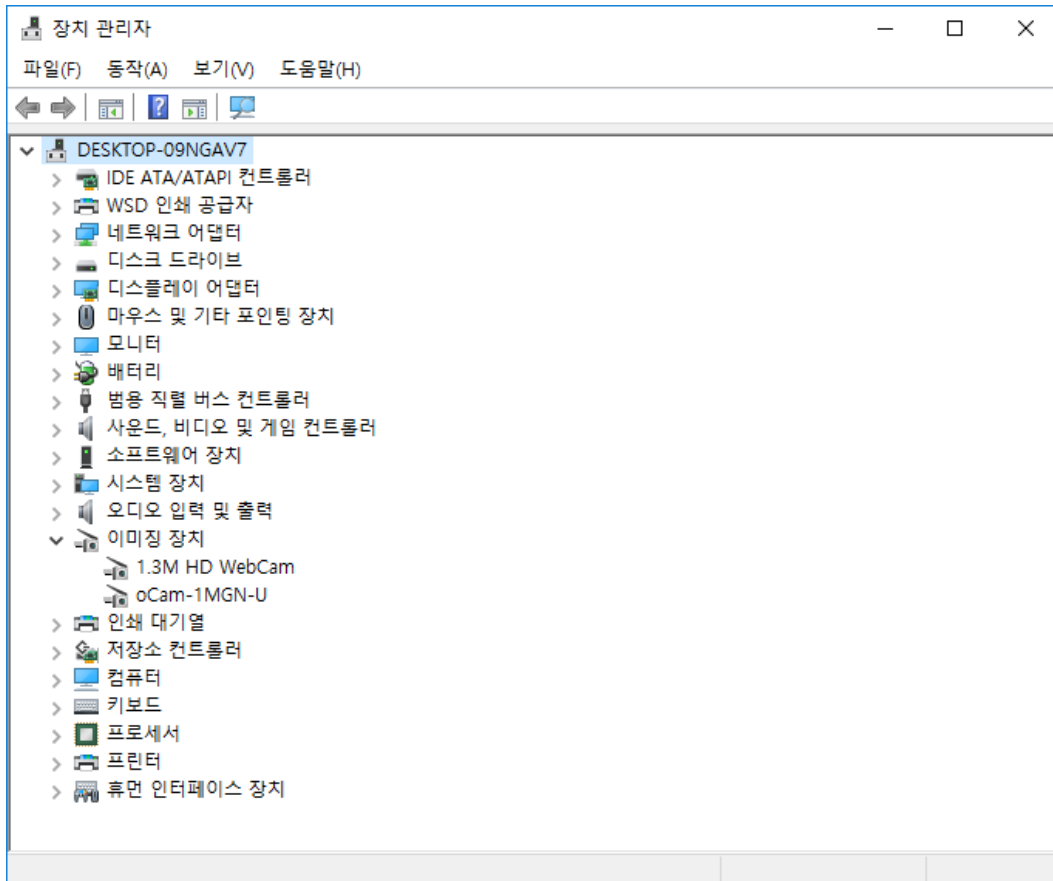

Figure 4 . Connection success message window

3.2. oCam-Viewer installation

- Open the site https://github.com/withrobot/oCam/tree/master/Software/oCam-viewer_Win/bin.
- Download the oCam-Viewer:
 - For 64bit system, download "libCamCap-amd64.dll" and "oCam-Viewer-amd64.exe".
 - For 32bit system, download "libCamCap.dll" and "oCam-Viewer.exe".

3.3. Run the oCam-Viewer

- Start oCam-Viewer.
- Once the oCam-1MGN-U is connected successfully, the viewer main window will appear as follows.

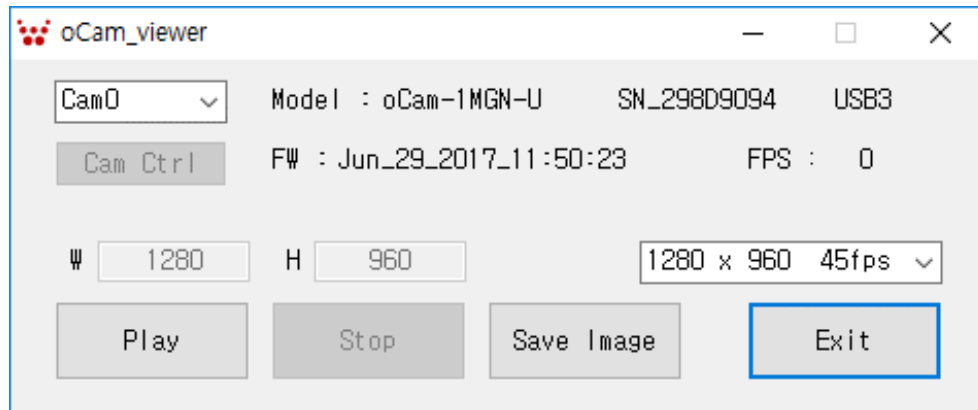

Figure 5. oCam-Viewer main window

- Click **[Play]** to show the image window.

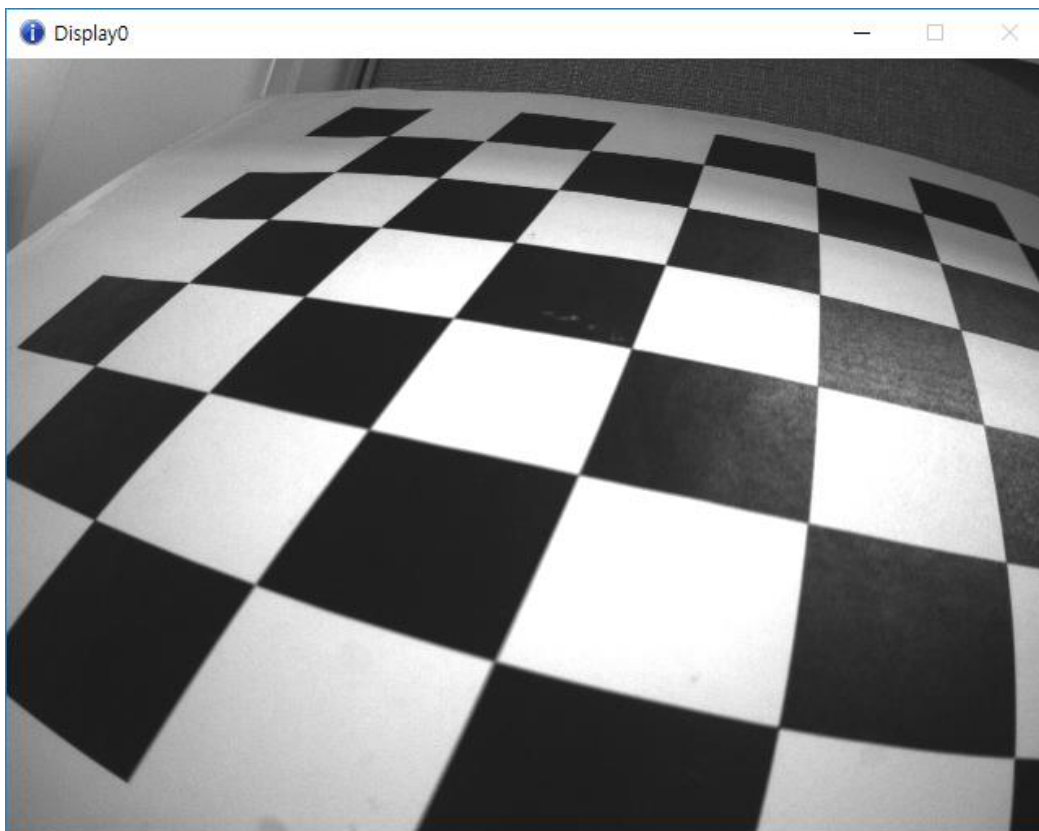

Figure 6. Camera image view window

- Click **[Stop]** and click the dropdown arrow to open the list of resolutions supported by the connected camera.

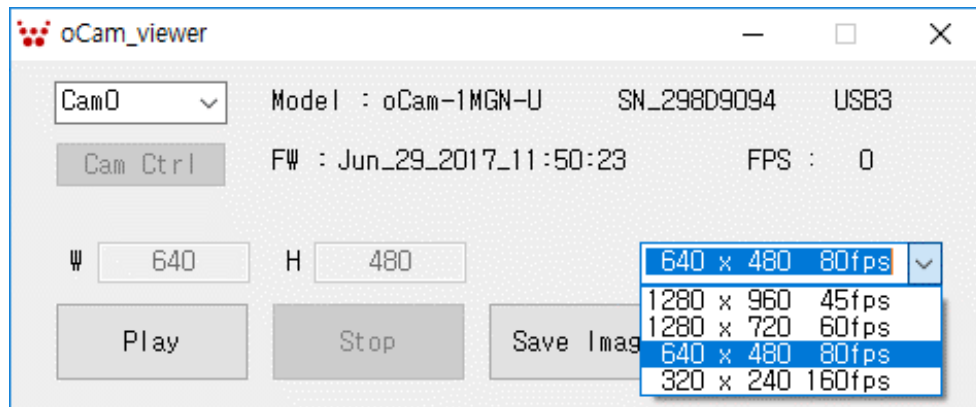
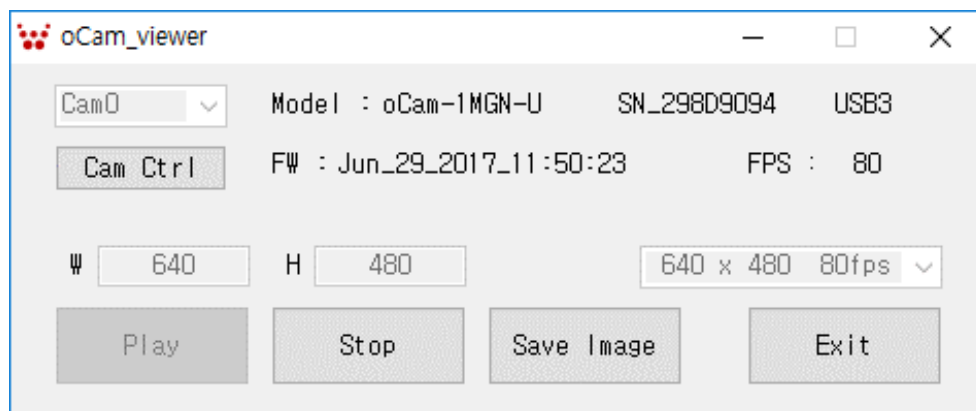

Figure 7. Image resolution list

- Click **[Stop]** and click **[Cam Ctrl]** to open the camera control window.



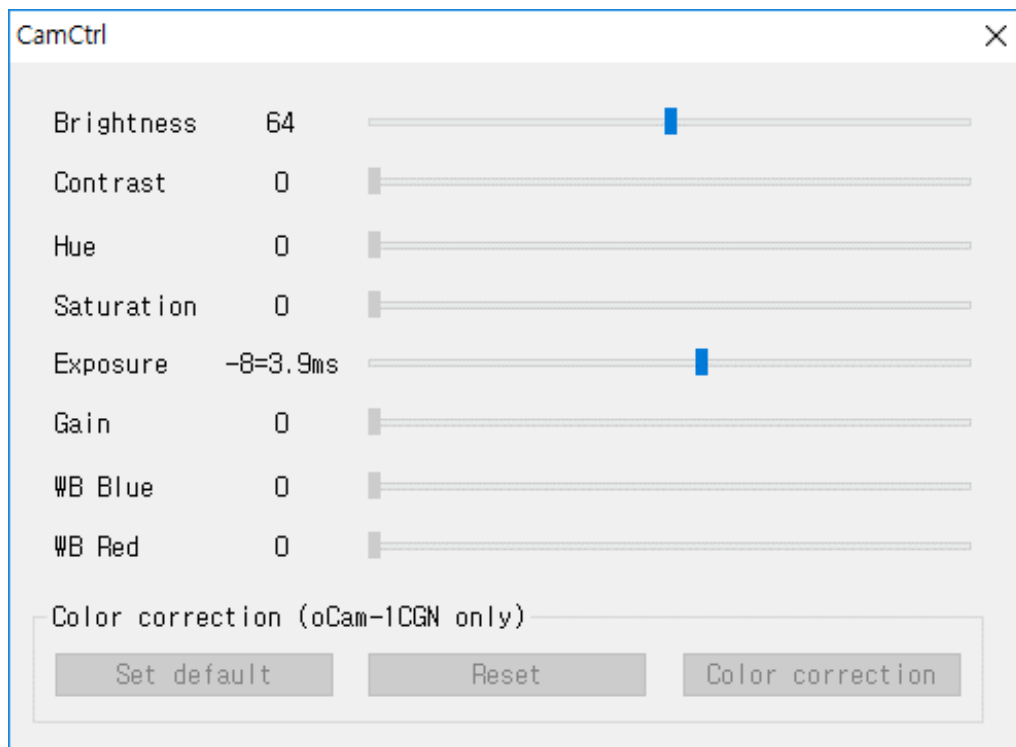

Figure 8. Camera control window

- Click **[Exit]** to terminate the program.

4. How to connect oCam-1MGN-U to Linux host

4.1. oCam-Viewer download & build

- Install the packages using the following commands.

```
$ sudo apt-get update
$ sudo apt-get install qt4-default libv4l-dev libudev-dev
```

- Create a working directory and download the source code into the working directory.
 - Here, the YOUR_WORKING_DIRECTORY should be set as the directory name that you choose.
 - The name of the source code can be different from the shown below as it is updated.

```
$ mkdir YOUR_WORKING_DIRECTORY
$ cd YOUR_WORKING_DIRECTORY
$ svn export
https://github.com/withrobot/oCam/trunk/Software/oCam_viewer_Linux_1705
```

- Build the code using the following commands.

```
$ cd oCam_viwier_Linux_1705
$ mkdir build
$ cd ./build
$ qmake ..
$ make release
```

- Run the viewer using the following command.

```
$ ./oCam-viewer
```

4.2. Connection of oCam-1MGN-U to host computer

- Insert USB3.0 cable into the oCam-1MGN-U.
- Connect USB3.0 cable to USB3.0 port of the host computer.
- Run "lsusb" to check the connection status.
 - "Cypress Semiconductor Corp" should appear as Cypress FX3 is used in the oCam-1MGN-U.
 - On successful connection of USB3.0, ID appears as "04b4:00f9".
 - If the connection is made as USB2.0, ID appears as "04b4:00f8".

```
$ lsusb  
Bus 004 Device 026: ID 04b4:00f9 Cypress Semiconductor Corp.
```

4.3. Run the oCam-Viewer

- If the oCam-1MGN-U is connected successfully, the following window should appear on the execution of the oCam-Viewer.
 - The device name and the serial number should appear correctly.

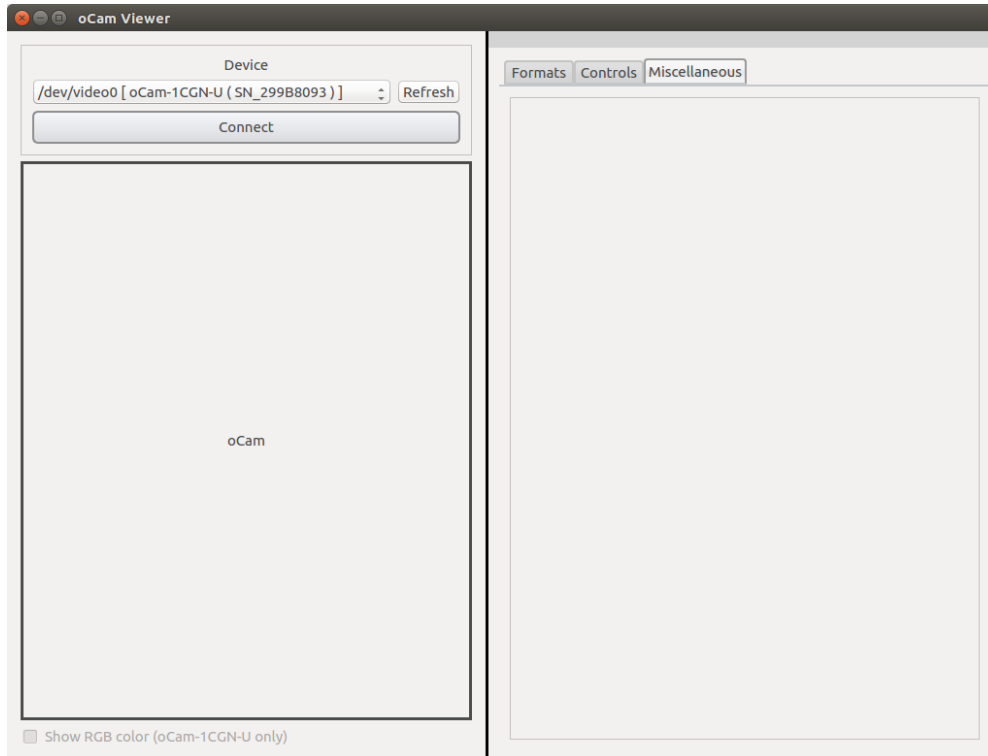

Figure 9. oCam-Viewer window on Linux host

- Click **[Connect]** to open the image window.
- Select tabs on the right.
 - **[Formats]** shows the image formats.

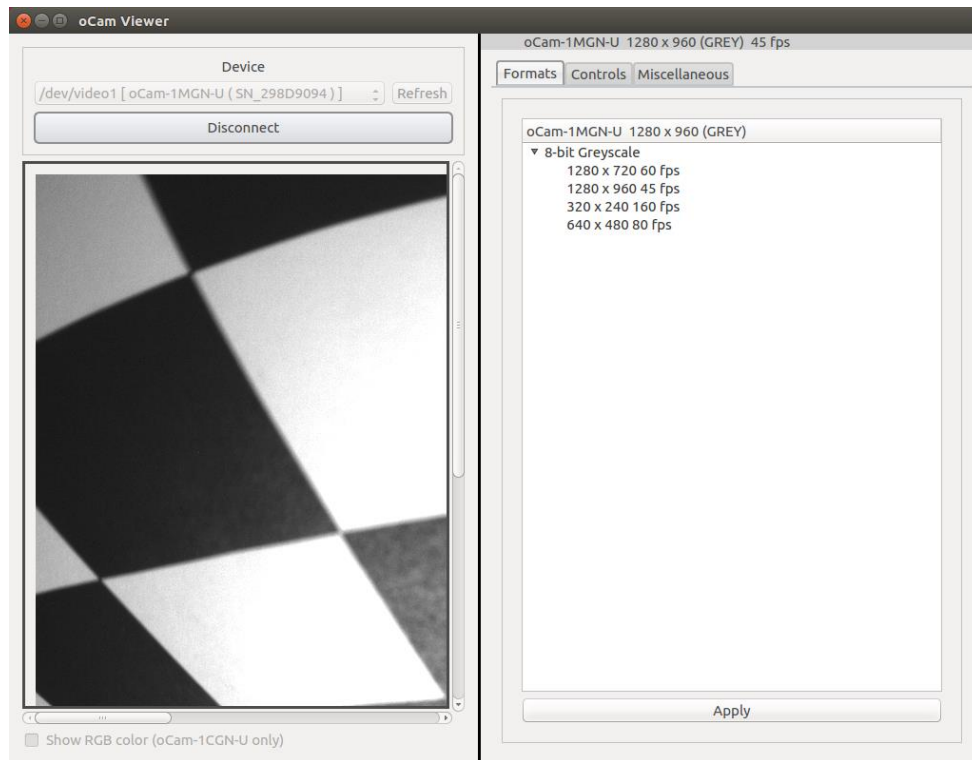

Figure 10. Image formats

- **[Controls]** shows the control parameters.

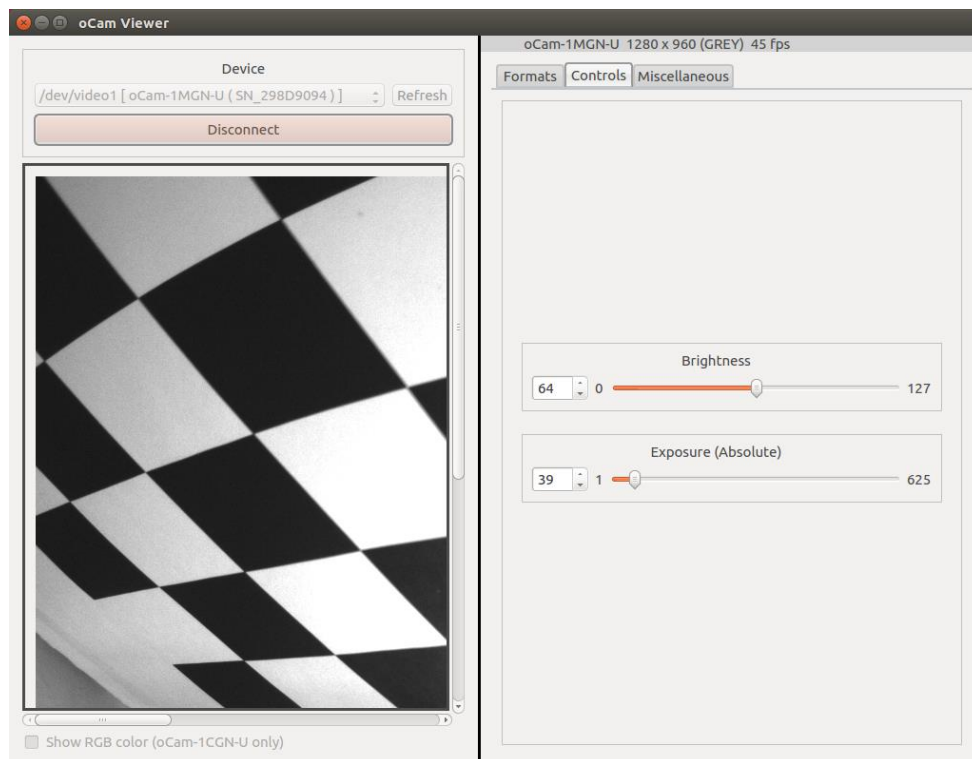

Figure 11. Image control parameters.

5. Firmware update

- You can find the latest firmware at <https://github.com/withrobot/oCam/tree/master/Firmware> .
 - Correct file for the oCam-1MGN-U should be selected for the firmware update.
- You can find the firmware writing program at <https://github.com/withrobot/oCam/tree/master/Firmware> .
 - Uncompress the downloaded "UpdateFW.ZIP".
 - Follow the instruction described at <https://github.com/withrobot/oCam/tree/master/Firmware>.

6. Recommendations

- The oCam-1MGN-U supports interchangeable M12 lens. Accordingly, the lens can be rotated under vibration. It is recommended to fix the lens in vibrating environment with glue.
- On the resolution of 320 x 240, the image is cropped from the full resolution. Therefore, the field of view will be reduced accordingly.
- The exposure time affects the image rate. With higher exposure, the FPS will drop as the camera uses longer time for acquiring the image. For higher FPS, the exposure time should be reduced.
- There are differences on the sensitivity of pixels in an image sensor with the global shutter mechanism. For high gain, the output of those pixels with higher sensitivity will be saturated, providing noises as a consequence. It is recommended to use low gain for less noisy image.

7. FAQs

7.1. Gvvcview

- On Linux host, you can use `gvcview` to view the image of the oCam-1MGN-U.
- Download the `gvcview` using the following commands.

```
$ sudo apt-get install gvcview  
$ gvcview -d /dev/video0
```

7.2. DIY Fixture

- As a DIY fixture for oCam-1MGN-U, the 3D printable files are available at https://github.com/withrobot/oCam/tree/master/DIY_Fixture.

7.3. Technical support

- E-mail technical support is available at withrobot@withrobot.com.

APPENDIX

1. Default M12 lens specifications

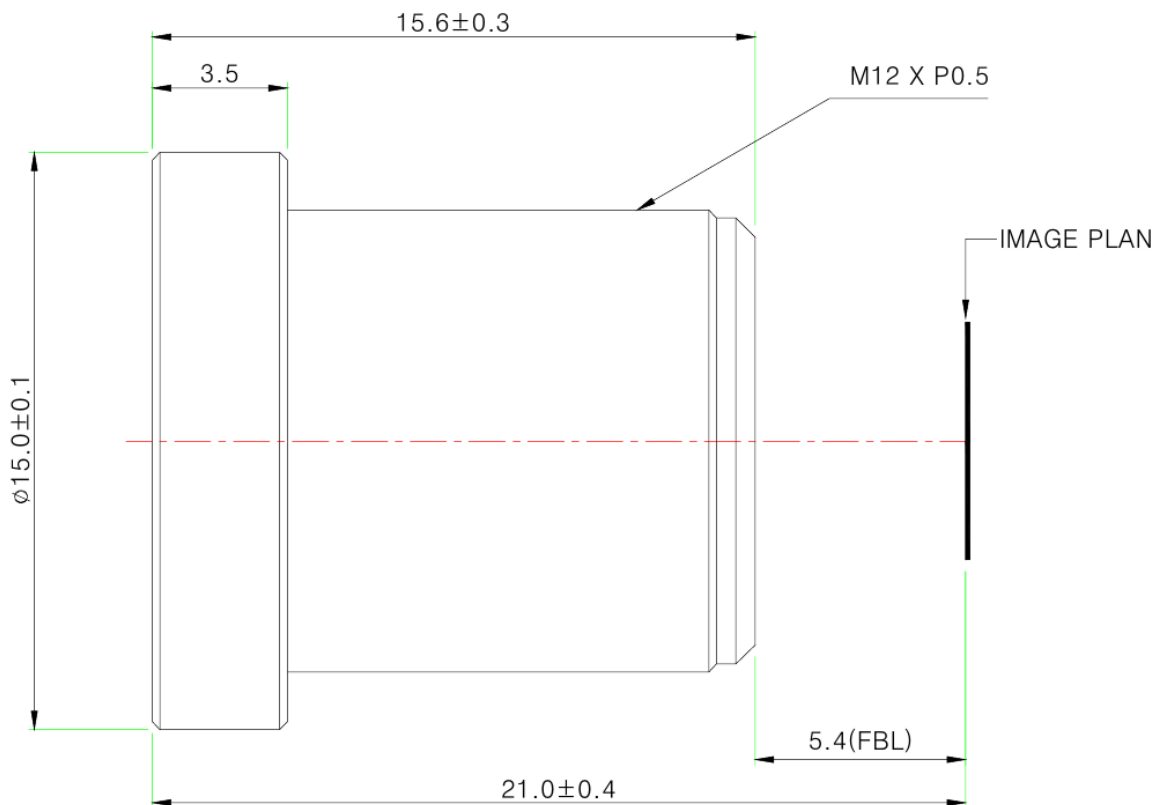

Item	Description
Focal Length	3.6mm $\pm 5\%$
Relative Aperture	2.0
Image Size	1/2.9", 1/2.7"
Angle Of View	1/2.9" : 50°(V) X 92.8°(H) X 110°(D) 1/2.7" : 59°(V) X 103°(H) X 125°(D)
Back Focal Length	6.17mm $\pm 5\%$
Flange Back Length	5.4mm ± 0.2 mm
Lens Length	15.6mm ± 0.3 mm
TTL	21.0mm ± 0.4 mm
MTF on-axis(at 50 lp/mm) 0.7F (at 50 lp/mm)	87.5% 86.2%(R), 78.4%(T)

Relative Illumination	44.5%(Full image circle)
Flange Type	M12 * P0.5
Head Size	φ 15.0
Operating Temperature Range	-20°C ~ +70°C, Under RH 90%
Storage Temperature Range	-25°C ~ +85°C , Under RH 99%
Lens Construction	4G [All Glass] With IR Cut Filter(650nm)

2. M12 lens holder dimensions

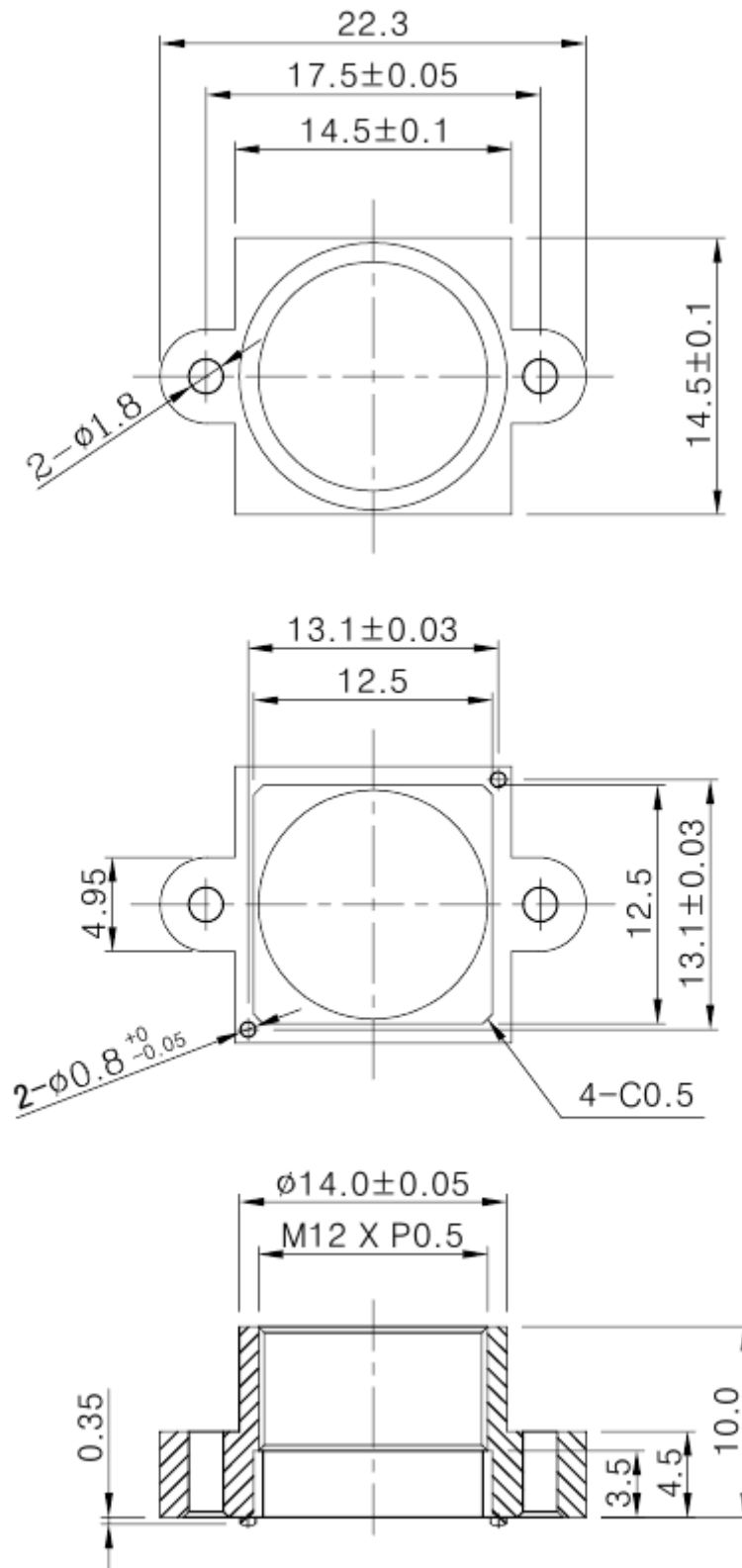

3. Tripod mount: oCam-TM

- Optionally available sold separately

